

Silverton Invite wkg

Silverton Invitational 2011

Jump to [Team scores](#)

Jump to bracket:			
106	113	120	126
132	138	145	152
160	170	182	195
220	285		

Team scores [\(back to top\)](#)

Team name	Score	Placers	Wins	Losses	P Falls	T Falls	M Decs
Silverton (Slvr)	296.0	16	46	27	31	0	6
Beaverton (Bvrt)	223.0	12	35	20	22	0	1
Wilson (Wlsn)	179.5	10	27	22	17	1	1
Gervais (Grvs)	169.0	12	30	33	20	0	0
Jefferson (Jffr)	141.0	8	24	13	13	0	4
Parkrose (Prkr)	134.0	9	23	20	16	0	1
Renegades (Rngd)	81.0	5	19	28	13	0	1
Benson (Ben)	74.0	4	15	22	13	0	0
Grant (Grnt)	51.0	4	8	13	5	0	0

106 [\(back to top\)](#)

Silverton Invite

Henry Houghton (Grant)	1	C. Goin (Slvr)	165	Champion A. Grag (Jffr) Pin 1:52	1. Anthony Grag (Jffr) 2. Cayman Goin (Slvr) 3. Henry Houghton (Grnt)
Cayman Goin (Silverton)		Pin 3:06			
Anthony Grag (Jefferson)	2	A. Grag (Jffr)			
		BYE			
H. Houghton (Grnt)	84	Third			
L-1		H. Houghton (Grnt)			
		BYE			
L-2					
	83	Fifth			
		None			

113 [\(back to top\)](#)

Iban Gomez (Gervais)

1. Iban Gomez

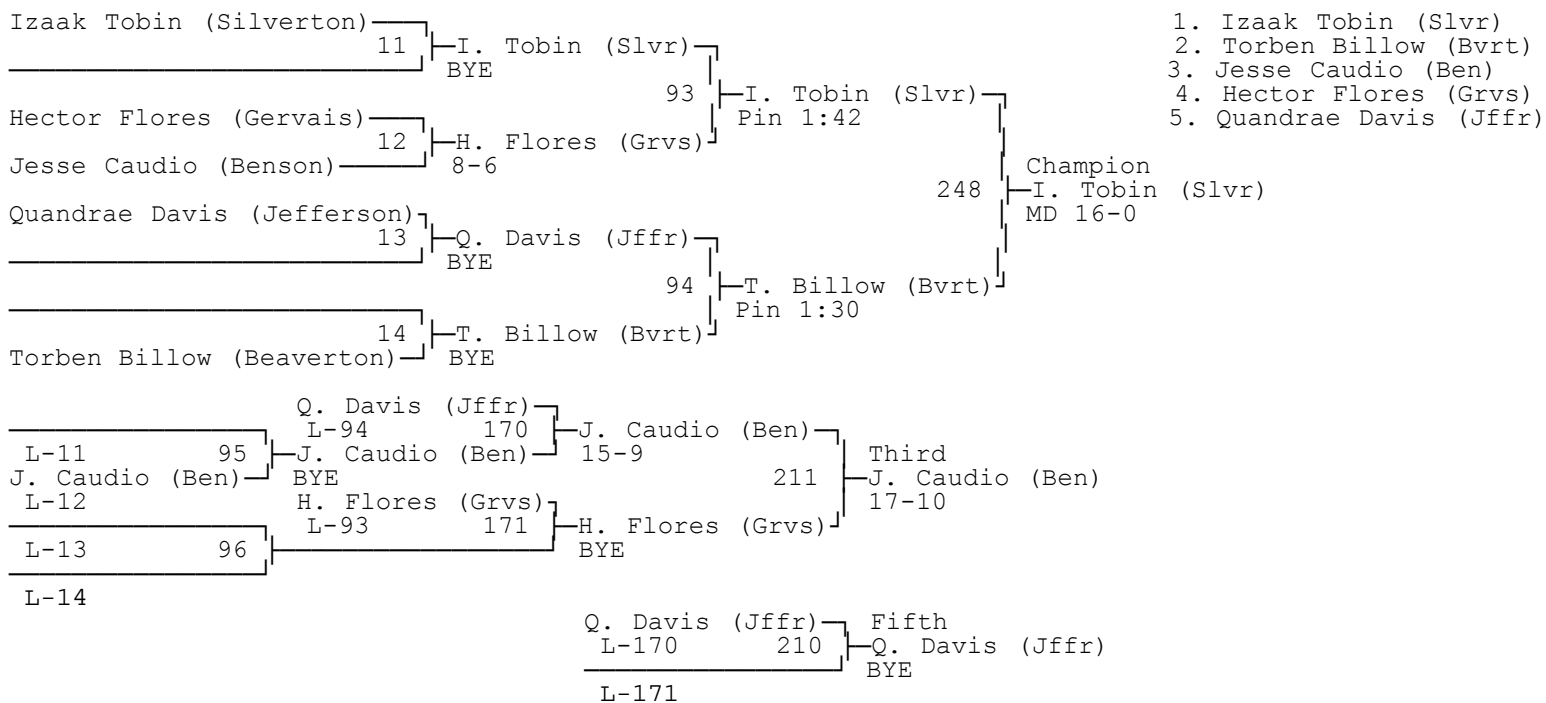

132 (back to top)

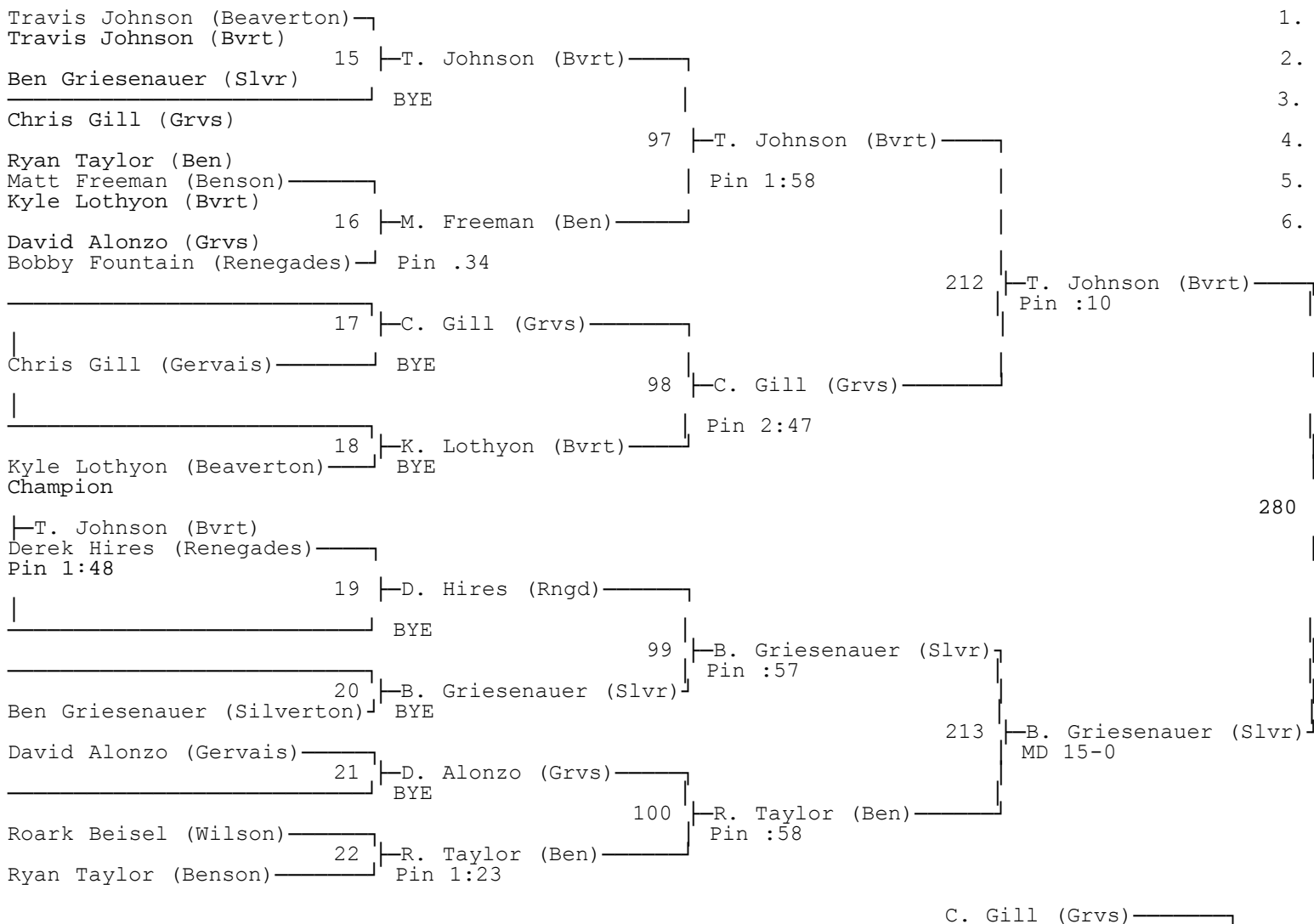

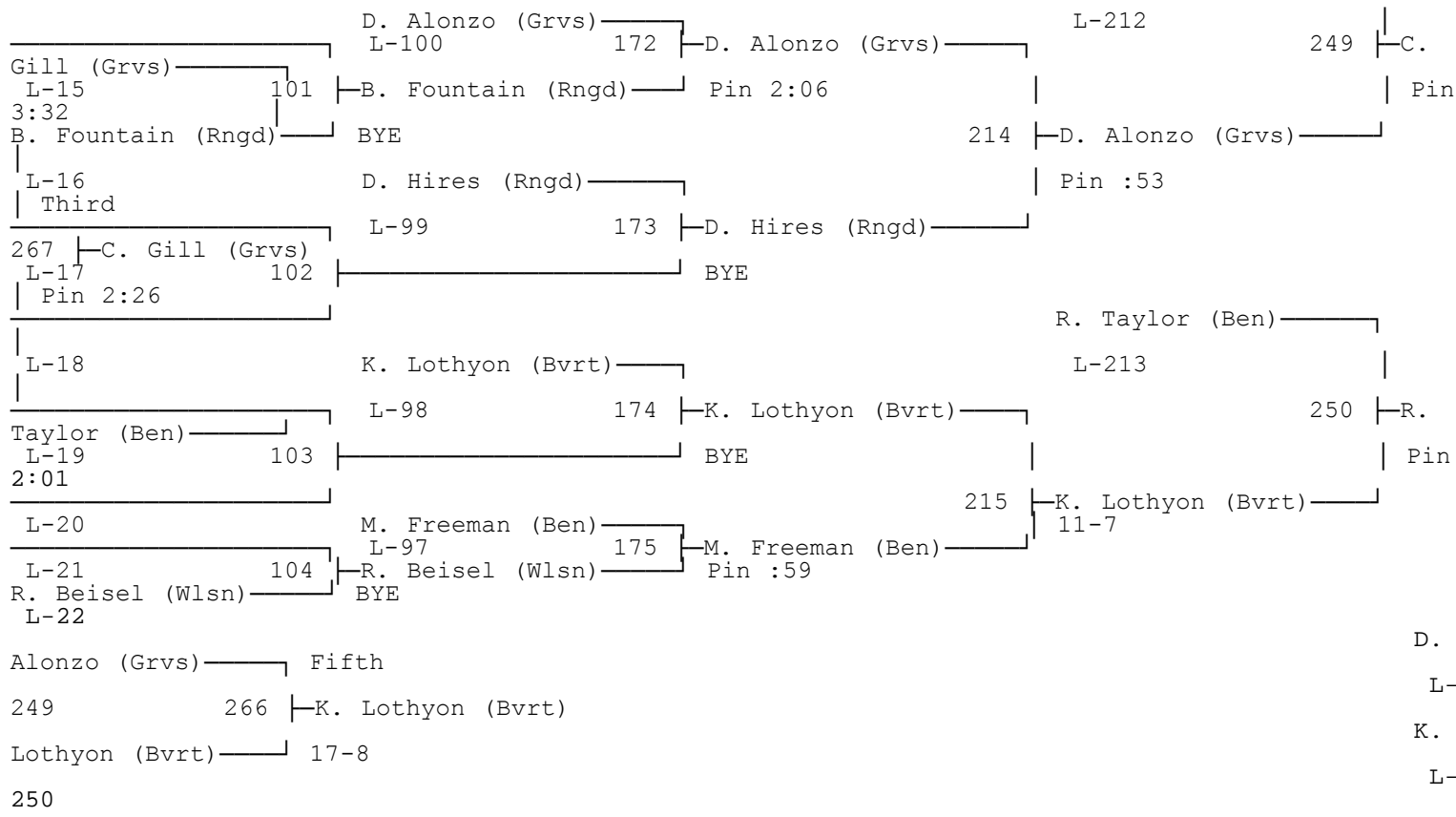

138 (back to top)

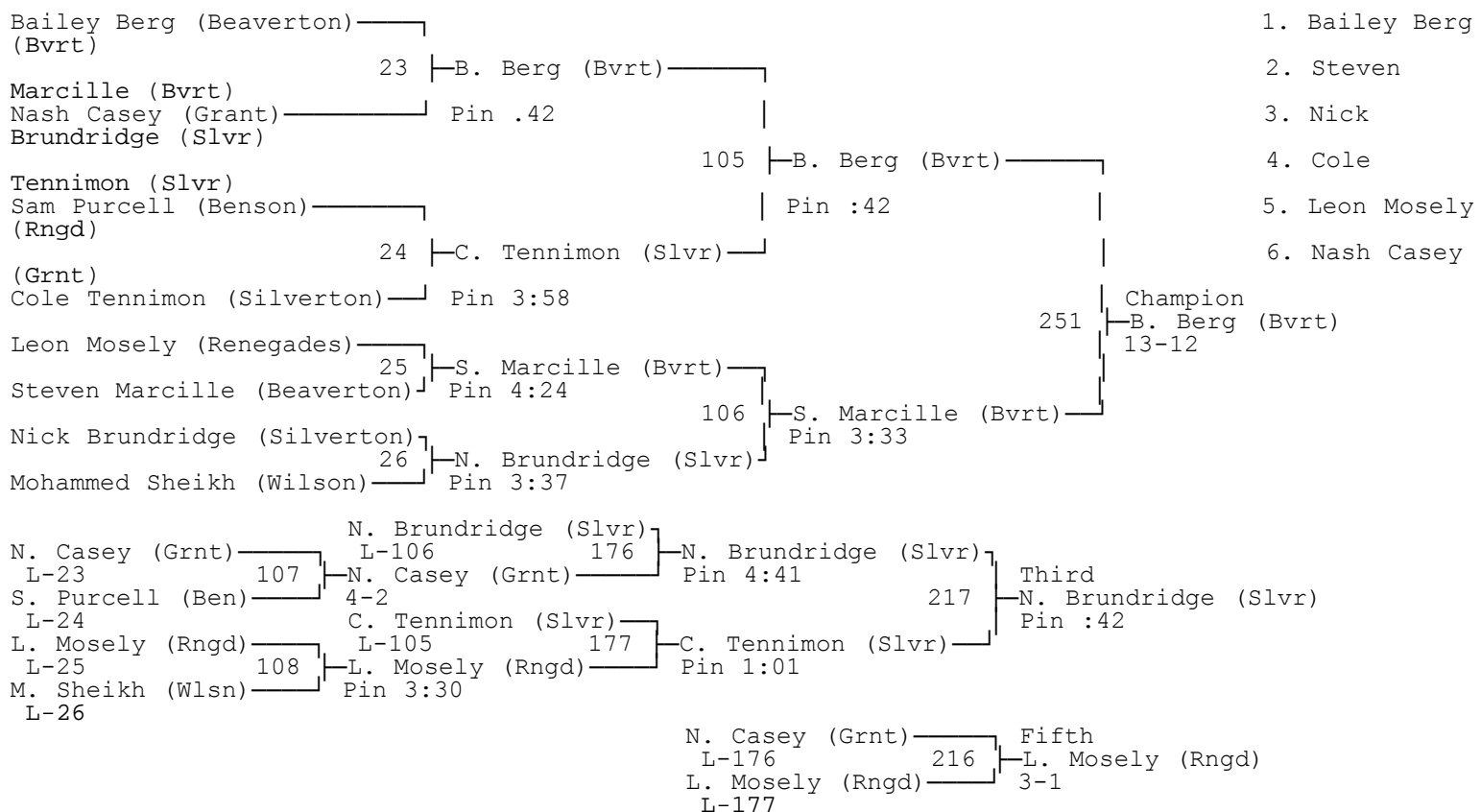

145 (back to top)

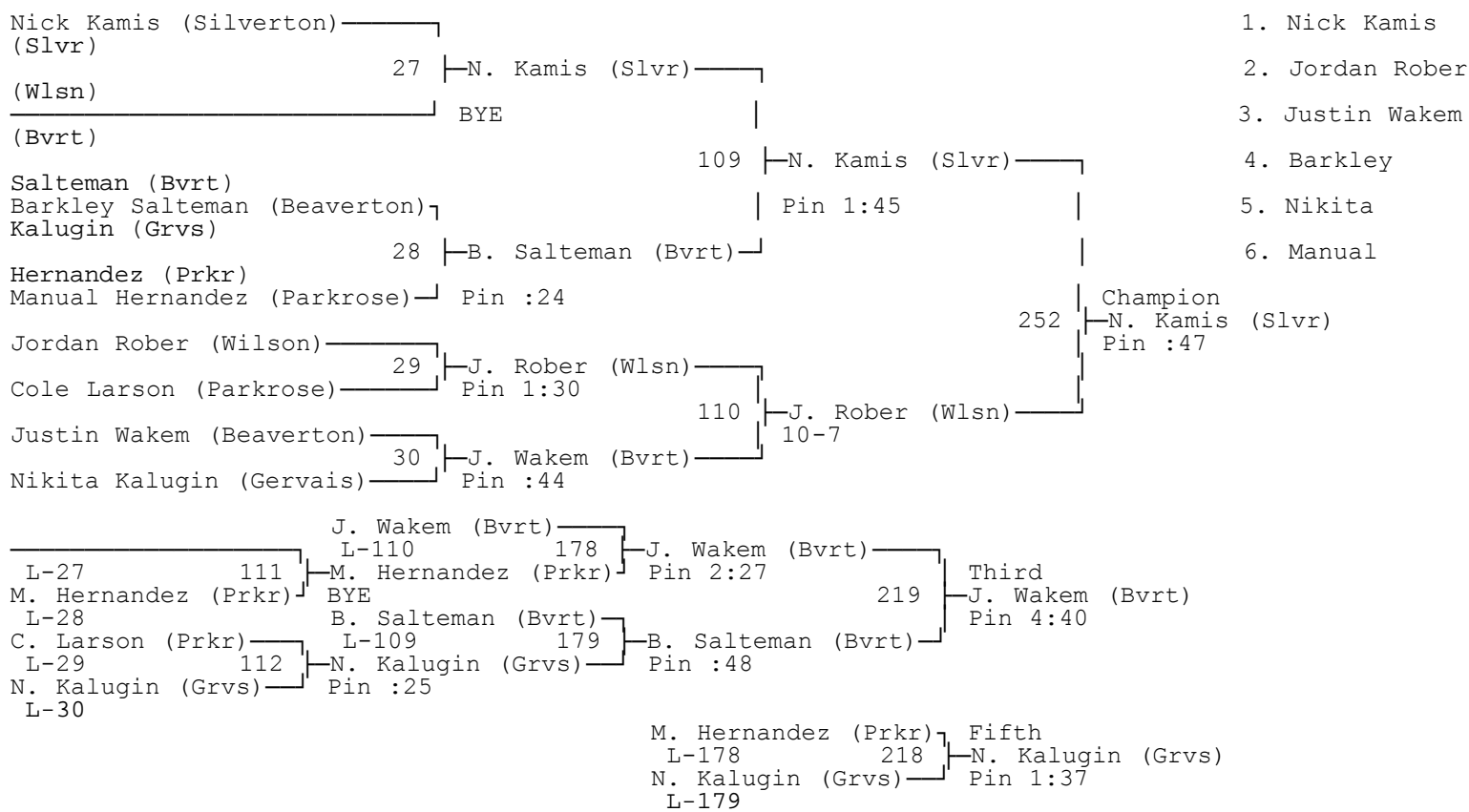

152 (back to top)

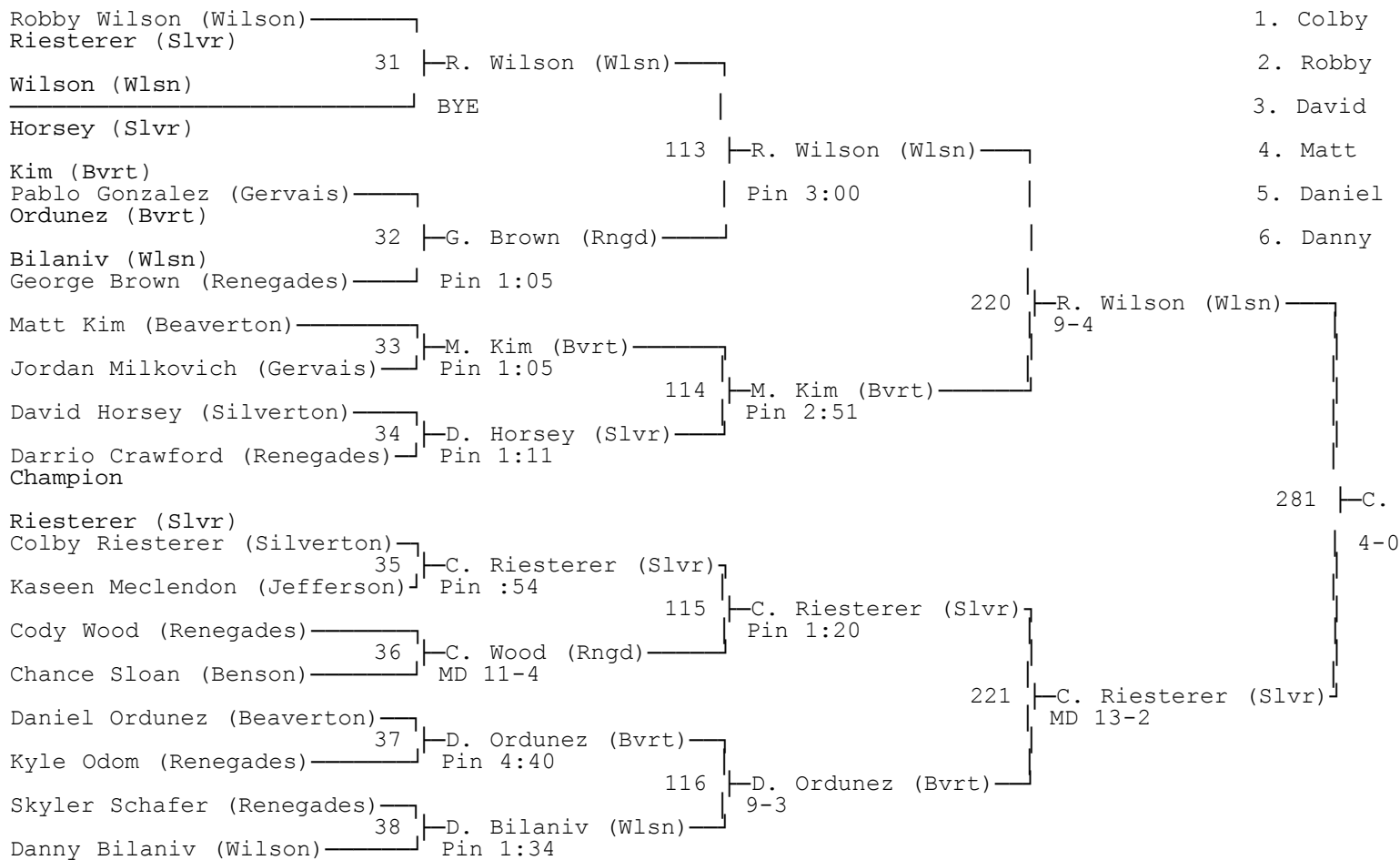

(Bvrt)		D. Bilaniv (Wlsn)		M. Kim (Bvrt)	
L-31	117	L-116	180	L-220	253
					M. Kim
		P. Gonzalez (Grvs)	Pin :45		7-5
		BYE		222	D. Bilaniv (Wlsn)
L-32		C. Wood (Rngd)			Pin 4:09
Third					
J. Milkovich (Grvs)		L-115	181		D. Crawford (Rngd)
269		D. Horsey (Slvr)			
L-33	118				D. Crawford (Rngd)
16-4					16-1
D. Crawford (Rngd)		Pin :30			D. Ordunez (Bvrt)
L-34		D. Horsey (Slvr)			L-221
K. Meclendon (Jffr)		L-114	182		D. Horsey (Slvr)
(Slvr)					254
L-35	119				D. Horsey
		K. Meclendon (Jffr)	Pin 2:31		Pin 1:32
C. Sloan (Ben)		Pin 1:26		223	D. Horsey (Slvr)
L-36		G. Brown (Rngd)			Inj Def
K. Odom (Rngd)		L-113	183		
L-37	120				G. Brown (Rngd)
		K. Odom (Rngd)	Pin :26		
S. Schafer (Rngd)		Pin 2:35			
L-38					
					D. Bilaniv
(Wlsn)		Fifth			L-253
268		D. Ordunez (Bvrt)			D. Ordunez
(Bvrt)		Forf 5x			L-254

160 (back to top)

Brian Huebner (Wilson)					
1. Brian Huebner (Wlsn)					
	39				B. Huebner (Wlsn)
2. Haszell West (Jffr)					
		BYE			
3. Robert Akil (Jffr)					
				121	B. Huebner (Wlsn)
4. Eduardo Gongora (Prkr)					
Robert Akil (Jefferson)					MD 21-10
5. Andrew Rogers (Slvr)					
	40				T. Hansen (Grvs)
6. Tyler Hansen (Grvs)					
Tyler Hansen (Gervais)					DQ 6-1
(Wlsn)					224
Andrew Rogers (Silverton)					B. Huebner
					Pin 5:22
	41				A. Rogers (Slvr)
Ovet Gomez (Parkrose)					Pin 1:50
				122	A. Rogers (Slvr)
					MD 17-0
	42				R. Baugh (Ben)
Ryan Baugh (Benson)					BYE
Champion					
282					B. Huebner (Wlsn)
Jason Westmoreland (Silverton)					Pin 1:01
	43				J. Westmoreland (Slvr)
					BYE
				123	E. Gongora (Prkr)
Thomas Wallberg (Benson)					Pin 3:56

```

    44 |E. Gongora (Prkr)
Eduardo Gongora (Parkrose) Pin 1:17
(Jffr)
Jordan Shahrizi (Wilson)
Haszell West (Jefferson) 45 |H. West (Jffr)
    Pin 1:54
    124 |H. West (Jffr)
    Pin 3:25
Andrian Kalugin (Gervais) 46 |A. Kalugin (Grvs)
    BYE
    A. Kalugin (Grvs)
    L-124 184 |R. Akil (Jffr)
    R. Akil (Jffr) L-39 125 |R. Akil (Jffr)
    Pin 1:50 MD 15-2
    R. Akil (Jffr) BYE
    L-40 J. Westmoreland (Slvr)
    Third Pin :59
    O. Gomez (Prkr) L-123 185 |O. Gomez (Prkr)
    271 |R. Akil (Jffr)
    L-41 126 |O. Gomez (Prkr)
    Pin 5:00 Pin :45
    BYE
    L-42 R. Baugh (Ben)
    E. Gongora (Prkr) L-122 186 |R. Baugh (Ben)
    L-43 127 |T. Wallberg (Ben)
    Pin 3:31 Pin 2:17
    T. Wallberg (Ben) BYE
    L-44 T. Hansen (Grvs)
    J. Shahrizi (Wlsn) L-121 187 |T. Hansen (Grvs)
    L-45 128 |J. Shahrizi (Wlsn)
    Pin 4:39
    BYE
    L-46
A. Rogers (Slvr) Fifth
L-255 270 |A. Rogers (Slvr)
T. Hansen (Grvs) Forf 5x
L-256

```

170 (back to top)

```

Quinn Dreher (Silverton)
Dreher (Slvr) 47 |Q. Dreher (Slvr)
Wolpert (Prkr) BYE
Turner (Jffr) 129 |Q. Dreher (Slvr)
    Pin 1:44
Kolin (Wlsn)
Jake Kolin (Wilson)
Davis (Rngd) 48 |J. Kolin (Wlsn)
Anastas (Wlsn)
Gerald Richardson (Benson) Pin 2:28
Luke Taylor (Grant) 49 |L. Taylor (Grnt)
    BYE
    130 |K. Turner (Jffr)
    MD 19-9
Kelsic Turner (Jefferson) 50 |K. Turner (Jffr)
    BYE
    228 |Q. Dreher (Slvr)
    Pin 2:56
    283 |Q.
Dreher (Slvr)

```

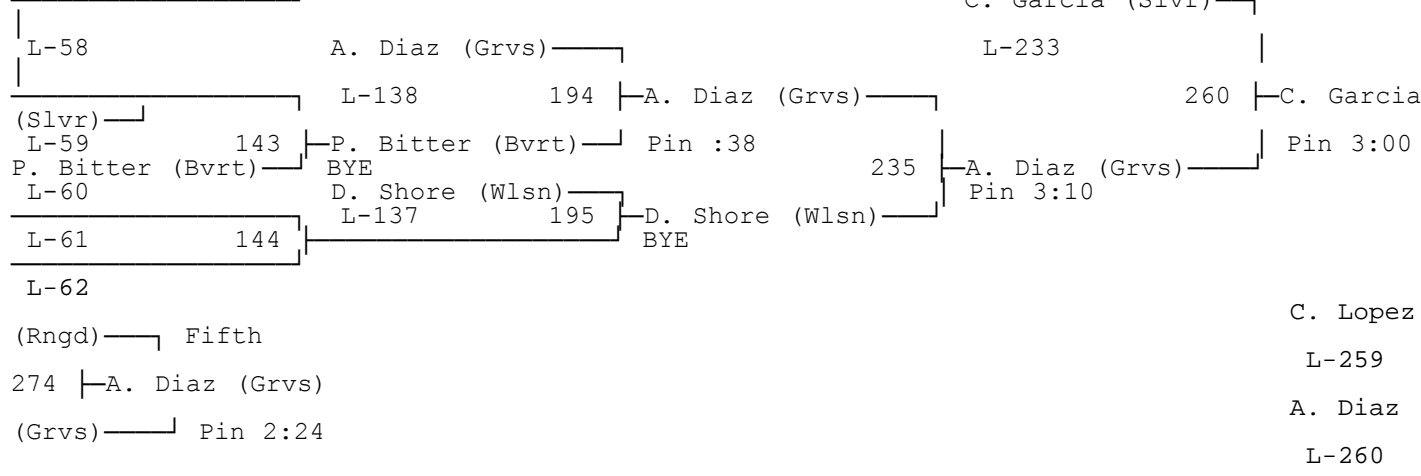
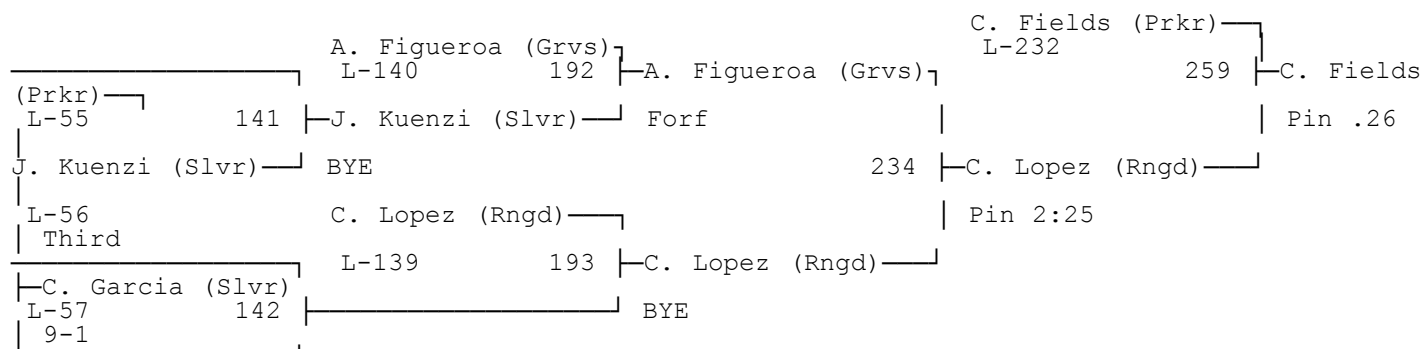
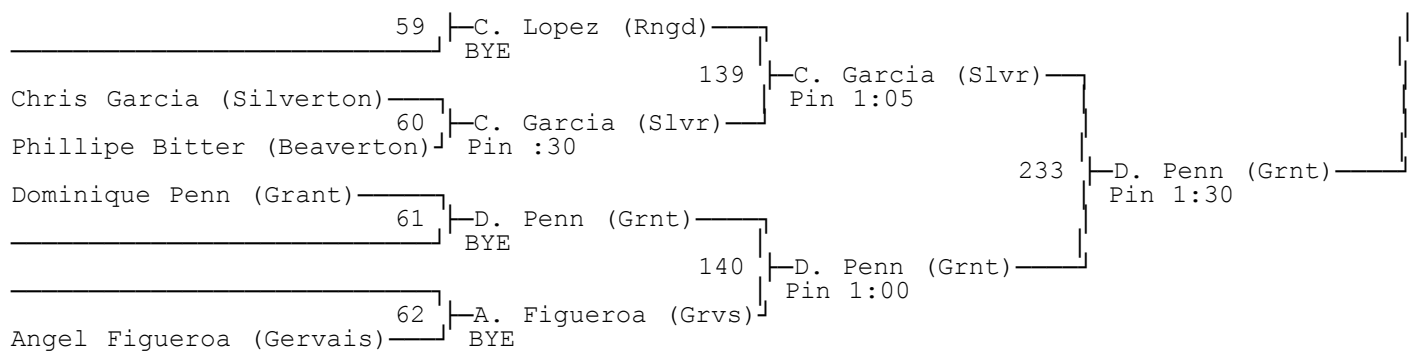
195 (back to top)

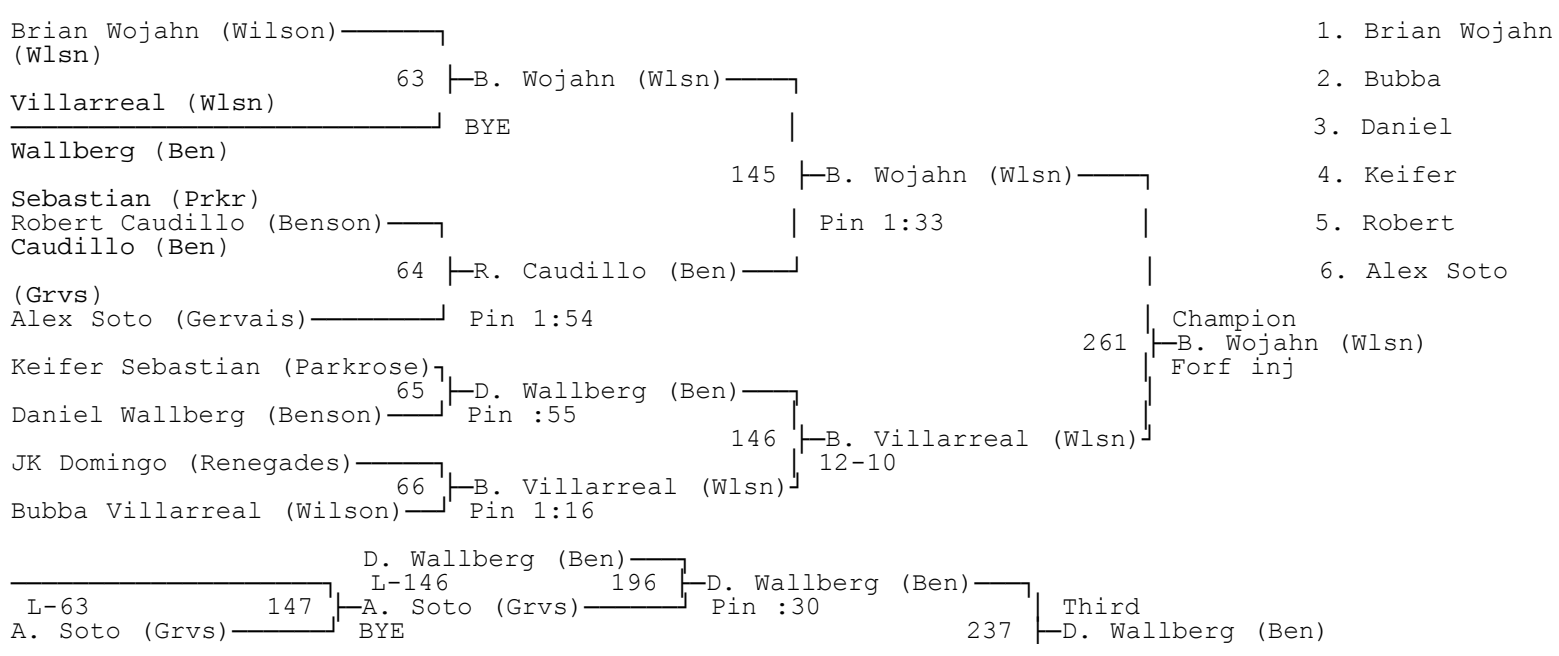

(Jffr) 7 Fifth
 276 B. Redeau (Grnt)
 (Grnt) Forf 5x

A. Williams
 L-262
 B. Redeau
 L-263

285 (back to top)

Dakota Sandoval (Gervais)				1. Jalean
Webb (Jffr)				2. John
O'Riely (Bvrt)	75	D. Sandoval (Grvs)		3. Hunter
Sexsmith (Prkr)		BYE		4. Cameryn
Clokey (Slvr)			157	J. O'Riely (Bvrt)
Taste Cross (Grant)				Pin :11
Zafra (Prkr)				5. Anthony
Goobles (Slvr)	76	J. O'Riely (Bvrt)		6. Cody
John O'Riely (Beaverton)		Pin 1:23		
Cody Goobles (Silverton)			242	J. O'Riely (Bvrt)
	77	C. Goobles (Slvr)		Pin 1:53
		BYE		
			158	A. Zafra (Prkr)
				Pin 2:20
	78	A. Zafra (Prkr)		
Anthony Zafra (Parkrose)		BYE		
Champion				
Webb (Jffr)				286
Jalean Webb (Jefferson)				Pin
1:12				
	79	J. Webb (Jffr)		
		BYE		
			159	J. Webb (Jffr)
				MD 11-0
	80	H. Sexsmith (Prkr)		
Hunter Sexsmith (Parkrose)		BYE		
			243	J. Webb (Jffr)
				Pin 3:20
Roberto Hernandez (Gervais)				
	81	R. Hernandez (Grvs)		
		BYE		
			160	C. Clokey (Slvr)
Cameryn Clokey (Silverton)				Pin 1:02
	82	C. Clokey (Slvr)		
		BYE		
		R. Hernandez (Grvs)		A. Zafra (Prkr)
		L-160	202	L-242
				264
		R. Hernandez (Grvs)		H. Sexsmith
				Pin 3:52
(Prkr)				
L-75	161	T. Cross (Grnt)		Pin 3:44
		BYE		
T. Cross (Grnt)			244	H. Sexsmith (Prkr)
				Pin 1:12
L-76		H. Sexsmith (Prkr)		
Third				
			L-159	203
				H. Sexsmith (Prkr)
279		H. Sexsmith (Prkr)		BYE
L-77	162			
Pin 2:02				
L-78		C. Goobles (Slvr)		C. Clokey (Slvr)
				L-243
			L-158	204
				C. Goobles (Slvr)
(Slvr)				265
L-79	163			C. Clokey
				Pin 0:42
L-80		D. Sandoval (Grvs)		
		L-157	205	
L-81	164			
		D. Sandoval (Grvs)		
		BYE		
			245	C. Goobles (Slvr)
				Pin :53
L-82				

(Prkr) — Fifth

278 | A. Zafra (Prkr)

(Slvr) — 8-4

A. Zafra

L-264

C. Goobles

L-265